

# Actuator

61-  
6461.4057

Distribution by  
Newark



<https://newark.eao.com/component/61-6461.4057...>

Your product:

---



## 61-6461.4057 Actuator

*Loading ...*

### FRONT

**Front dimension:** Ø 40 mm

**Front form:** Round

### MOUNTING

**Mounting type:** Panel mounting

### OPERATING-/INDICATION PART

**Lens colour:** Red

**Lens material:** Plastic

**Lens illumination:** Non illuminated

**Lens shape:** Mushroom-head

### ELECTRICAL CHARACTERISTICS

**Switching voltage and switching current:**

Alternating current usage category AC-15 according to EN IEC 60947-5-1	
Voltage	50 VAC
Current	0,2 A
DC usage category DC-13 according to EN IEC 60947-5-1	
Voltage	50 VDC
Current	0,2 A

**Contacts:** 2 NC

**Contact resistance:** At 20 mV, 100 mA (IEC 60512-2-1) Insulation resistance  
2 MΩ between the open contacts  
7 MΩ towards the panel (DIN IEC 60512-3-1)

**Rated Operational Voltage U<sub>e</sub>:** 50 VAC / DC, according to EN / IEC 60947-5-1

**Rated impulse withstand voltage U<sub>imp</sub>:** 0.5 kV, according to EN / IEC 60947-1

<b>Rated insulation voltage Ui:</b>	250 VAC/DC according to EN IEC 60947-1
<b>Rated short-circuit current caused:</b>	1 000 A, type of short-circuit device 2 A gG (EN 60947-5-1)
<b>Recommended minimum operational data:</b>	Voltage 1 VAC/DC Current 1 mA
<b>Switching rating:</b>	50 V AC/DC @ 0,2 A
<b>Electrical lifetime:</b>	≥20 000 cycles of operation
<b>Electric strength:</b>	500 VAC, 50 Hz, 1 minute according to DIN IEC 60512-2
<b>Overvoltage category:</b>	II, according to EN / IEC 61058-1
<b>Pollution degree:</b>	3, according to EN IEC 60947-1
<b>Standards:</b>	According to EN 60947-5-1, EN 60947-5-5, DIN EN ISO 13850, EN IEC 60204
<b>Thermal current I<sub>th</sub>:</b>	0.5 A (EN IEC 60947-5-1 / max. current in continuous operation at max. + 55 degrees C)

## MECHANICAL CHARACTERISTICS

<b>Terminal:</b>	Plug-in terminal, 2.8 x 0.5 mm
<b>Switching action:</b>	Maintained
<b>Release type:</b>	Twist to unlock
<b>Mechanical lifetime:</b>	≥20 000 cycles of operation
<b>Operating force:</b>	30 N ±4 N
<b>Operating Travel:</b>	4.2 mm
<b>Tightening torque:</b>	Max. 0.8 Nm
<b>Weight:</b>	0.02 kg

## AMBIENT CONDITION

<b>IP Protection:</b>	IP67 front side, according to EN IEC 60529/A1:2010-04, IP69K front side, according to EN IEC 60529/A1:2010-04, Panel surface roughness Ra1.6
<b>IK Protection:</b>	IK06
<b>Operating temperature:</b>	- 25 °C ... + 55 °C
<b>Storage temperature:</b>	- 40 °C ... + 85 °C
<b>Shock resistance:</b>	Max. 150 m / s <sup>2</sup> , pulse width 11 ms, 3-axis, (semi-sinusoidal as per EN IEC 60068-2-27)
<b>Vibration resistance:</b>	Max. 100 m / s <sup>2</sup> from 10 Hz ... 500 Hz, 20 cycles, 3-axis (sinusoidal EN IEC 60068-2-6)
<b>Climate resistance:</b>	Damp heat, steady: 56 days, + 40 °C/93 % relative humidity, according to EN IEC 60068-2-78

Dry heat: 96 hours, + 65 °C, as per EN IEC 60068-2-2  
Low temperature: 96 hours, – 25 °C (as per EN IEC 60068-2-1) ) UV test, 56 days  
(EN 60068-2-5:1999)

## CERTIFICATE

<b>Approbations:</b>	CB (EN 60947), UL NISD (cULus, UL EU) LISTED E-File-Nr.: E341760
<b>Conformities:</b>	CE, UKCA
<b>REACH:</b>	REACH compliant
<b>RoHS:</b>	RoHS compliant

## OTHER

<b>Short Description:</b>	Actuator, Ø 40 mm, Mushroom-head, Non illuminated, Red, Plastic, Round, 2 NC, Maintained, Plug-in terminal, 2.8 x 0.5 mm, Twist to unlock
<b>Dimension:</b>	Ø 40 mm
<b>Hints:</b>	Application as per DIN EN ISO 13850 and EN 60204-1 Seal Part No. 61-9900 Anti-twist ring No. 51-910 Fixing nut No. 51-991 Plug-in terminals 2.8 mm x 0.5 mm are solderable without UL certificate Front plate thickness 1 ... 4 mm with an anti-rotation ring Front plate thickness 1 ... 6 mm without an anti-rotation ring

## Wiring diagrams:

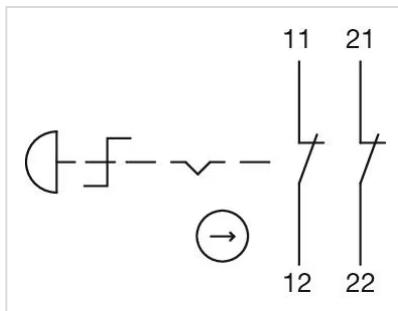

## Component layouts:

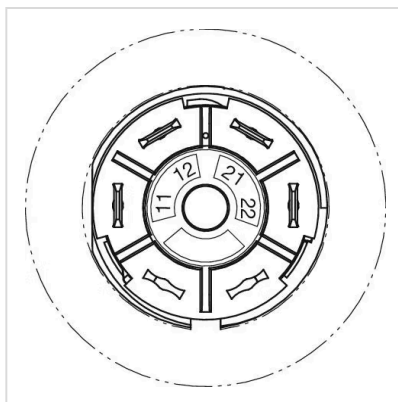

## Mounting cut-outs:

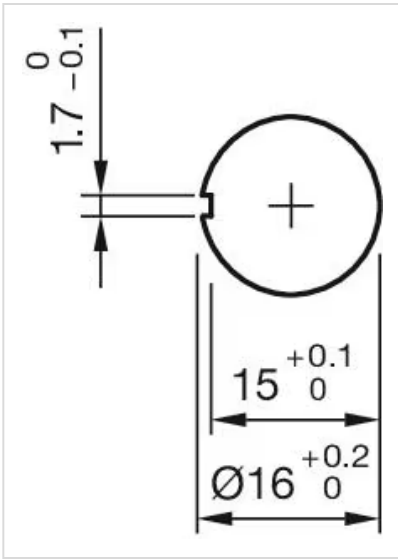

Dimension drawings:

